

Unless otherwise specified: Dimensions are in Millimeters			
Nominal size			
0.5 - 3.0:	±0.05	Surface Finish:	
3.0 - 6.0:	±0.1	Radius:	
6.0 - 30:	±0.2	Corner:	
30 - 120:	±0.3	Liner:	
120 - 315:	±0.5	Angular:	±2°
315 - 1000:	±0.8		

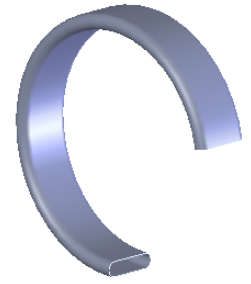

Debur and Break Sharp Edges

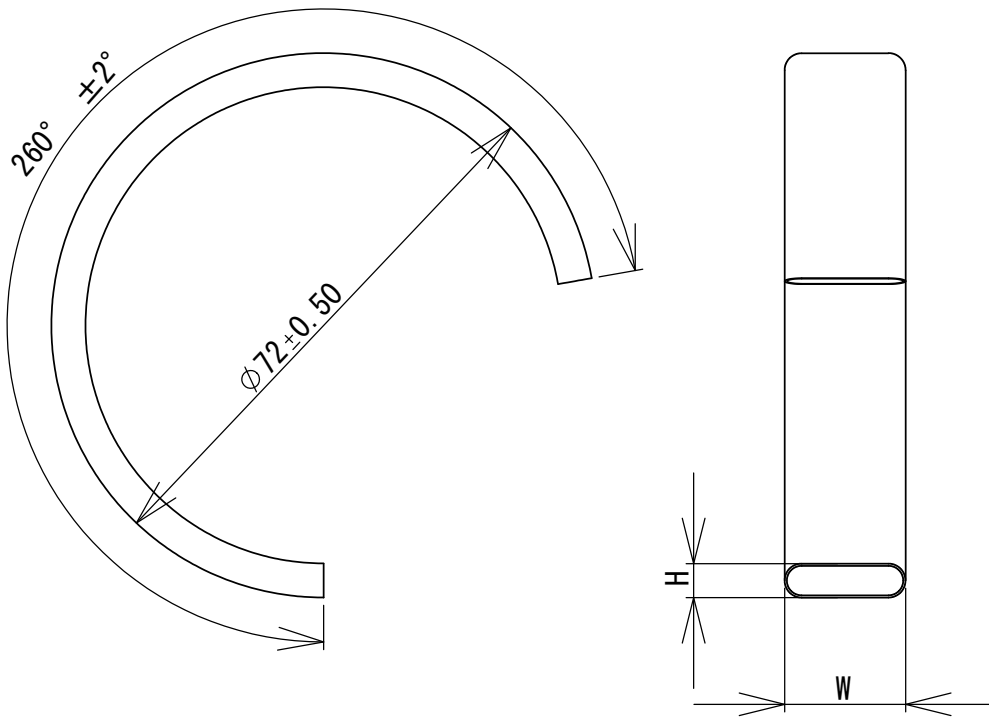

Scale (1:1)

Pressure Range (MPa)	Section Type	W	H	Tip Travel	Pressure Range (MPa)	Section Type	W	H	Tip Travel
		±0.30mm	±0.30mm	±0.25mm			±0.30mm	±0.30mm	±0.25mm
					0-1.0	C	16.3	4.5	4.8
					0-0.7	C	16.2	4.7	4.8
0-10.0	C	16.7	5.0	4.8	0-0.6	C	16.6	4.1	4.8
0-7.0	C	16.0	5.0	4.8	0-0.5	C	13.3	4.2	4.8
0-5.0	C	12.9	4.9	4.8	0-0.4	C	13.1	4.6	4.8
0-4.0	C	16.1	4.8	4.8	0-0.3	C	16.5	4.2	4.8
0-3.5	C	16.5	4.3	4.8	0-0.25	C	16.5	5.4	4.8
0-3.0	C	15.9	5.0	4.8	0-0.2	A	16.9	5.4	4.8
0-2.5	C	16.4	5.4	4.8	0-0.16	A	16.9	5.4	4.8
0-2.0	C	15.9	5.0	4.8	0-0.1	A	16.8	5.4	4.8
0-1.6	C	15.8	5.4	4.8	0-0.06	A	17.1	5.1	4.8

Parts Name: C-Type Bourdon Tube 72 mm OD SS

Material: SUS 316
AISI 316

Drawn: Kaz Miyasaka
Date: 2004/11/26

Drawing No. C72SS

FUJI BURUDON MFG CO LTD

Proprietary and Confidential

The information contained in this drawing is the sole property of Fuji Burudon MFG. Any reproduction in part or as a whole without the written permission of Fuji Burudon MFG. is prohibited.